

Takmarkise

Sorrento Grande

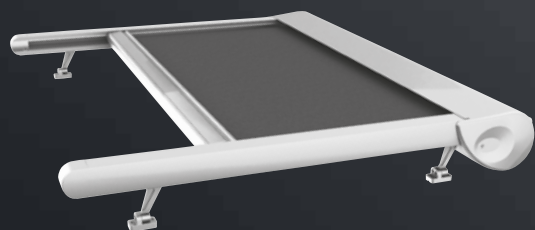

Et perfekt produkt til vinterhager er Sorrentomarkisen. Den gir en perfekt skjerming mot solen, og kan monteres enten oppå taket eller under taket. Sorrento er preget av solid utførelse av de beste aluminiumslegeringene, en harmonisk og ergonomisk form og gode bekvemmeligheter i daglig bruk.

Sorrento Grande – generell informasjon

Sorrento Grande kan monteres på to måter, oppå taket og under taket.

- universell bruk (installasjon oppå taket eller under taket)
- 100% produsert i Europa
- Max. størrelse 5,1 x 6,0 m

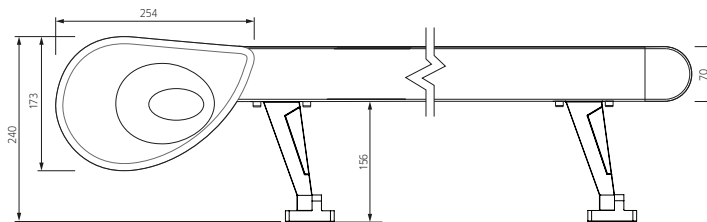

Montering

utenpåliggende montering (veggbraketter er valgfritt)

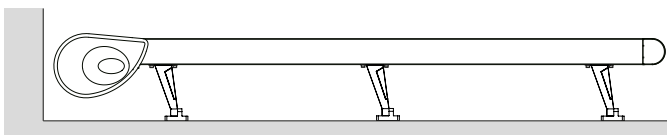

montering under tak (veggbraketter kreves)

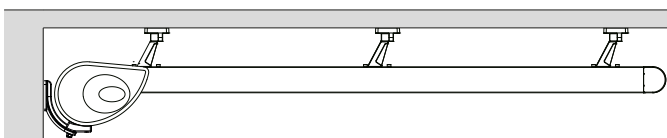

Sammenkopling

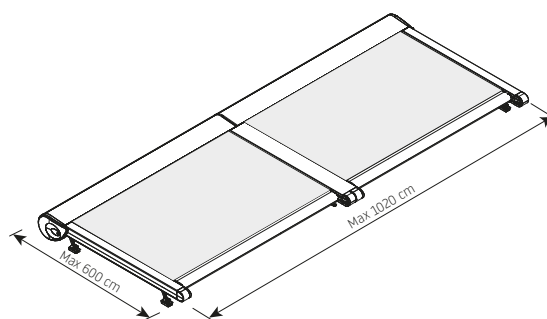

Standard farger

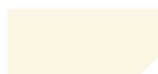

RAL 9001
Kremhvit



RAL 7s16
Antrasit
Strukturlakk



RAL 7s24
Grafittgrå
Strukturlakk

Bunnskinne

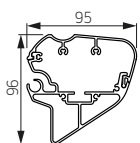

Styreskinner

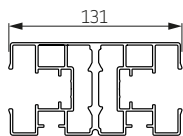
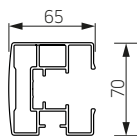

somfy

SergeFerrari
COMPOSITE TEXTILES FOR LIGHTNESS

DICKSON
composite shades for your world

**Sunshade
Experts**



HORNNES
Agenturer

Hornnesvegen 83, 6809 Førde - Tlf. 950 41 650

www.hornnes.no